

CILINDRO HIDROPNEUMÁTICO

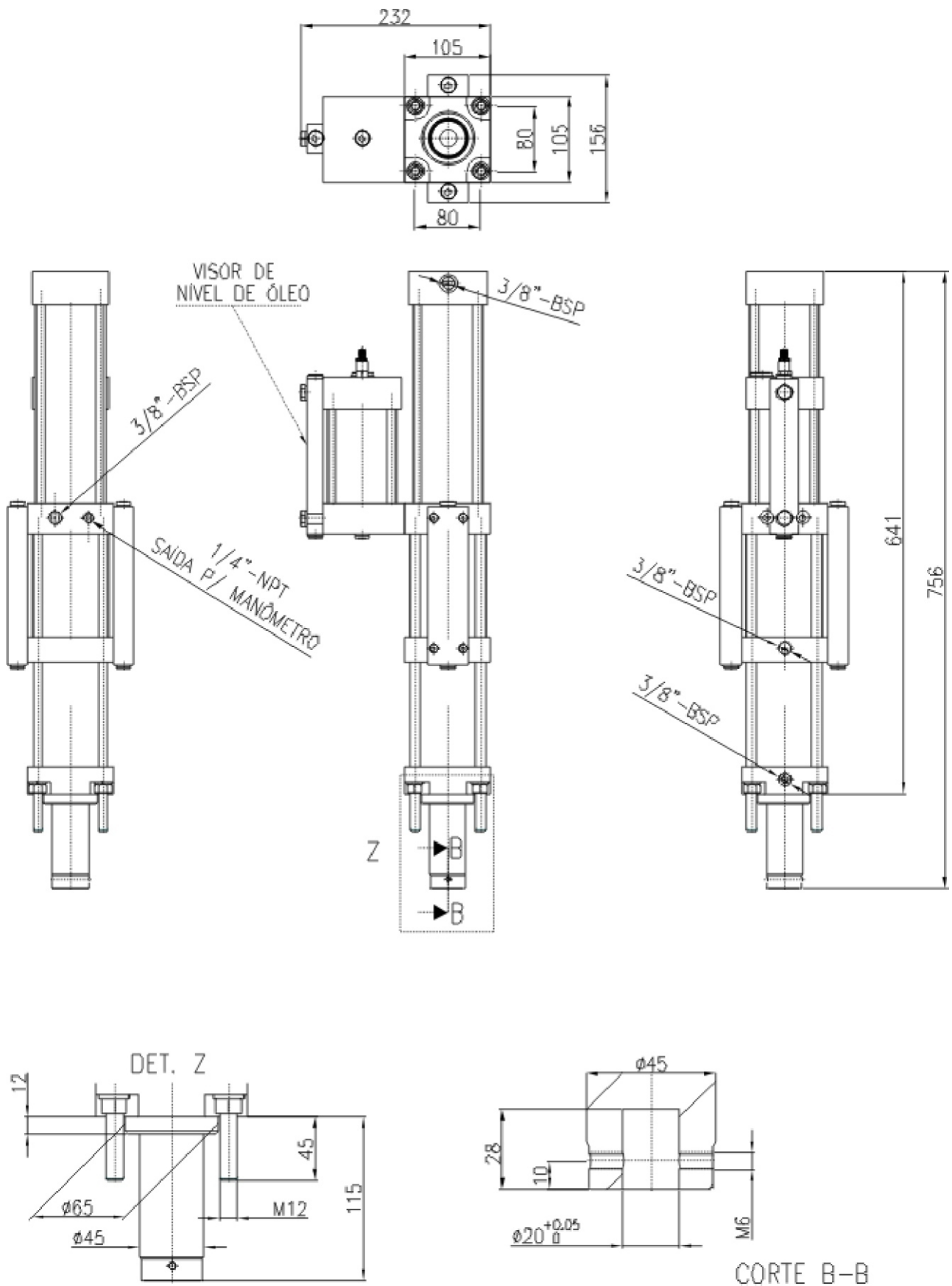

4000 KGF

MODELO : CHP-080-60-10-04
CURSO TOTAL = 60mm
CURSO HIDRÁULICO = 10mm



FORÇAS DE AVANÇO E RETORNO

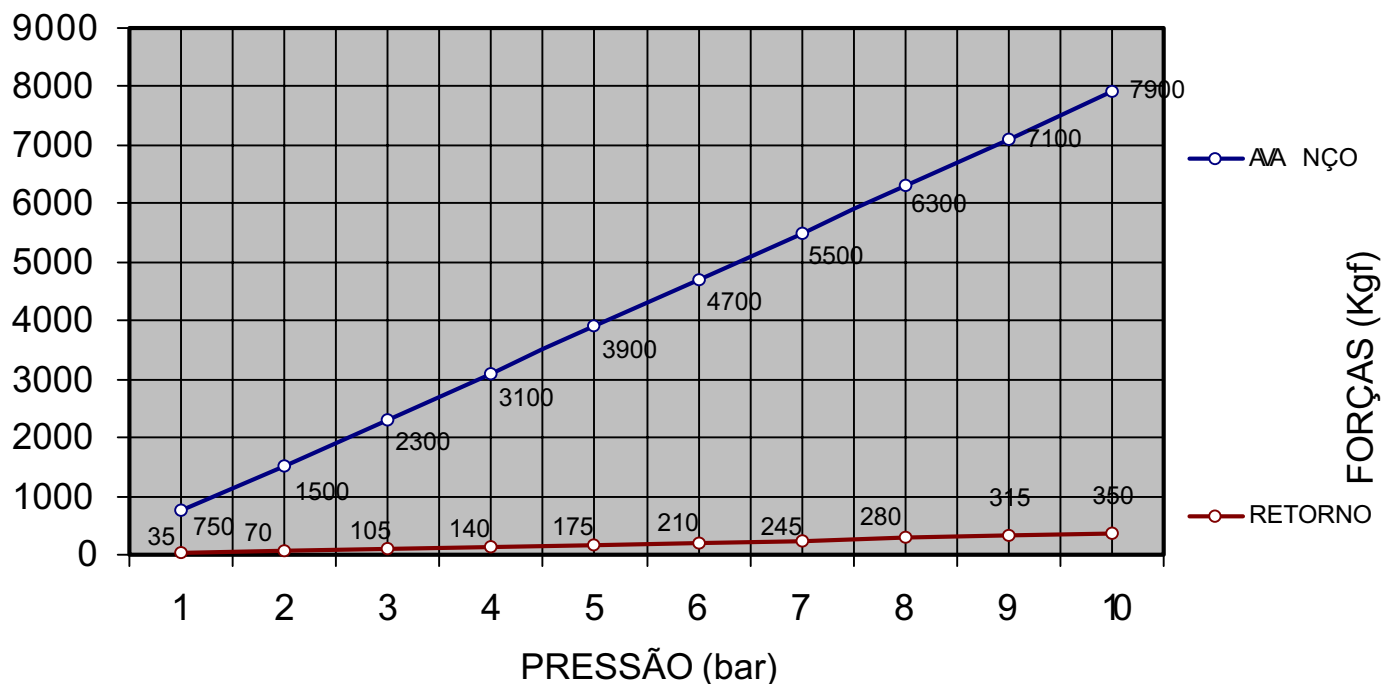

V (nl)

CONSUMO DE AR

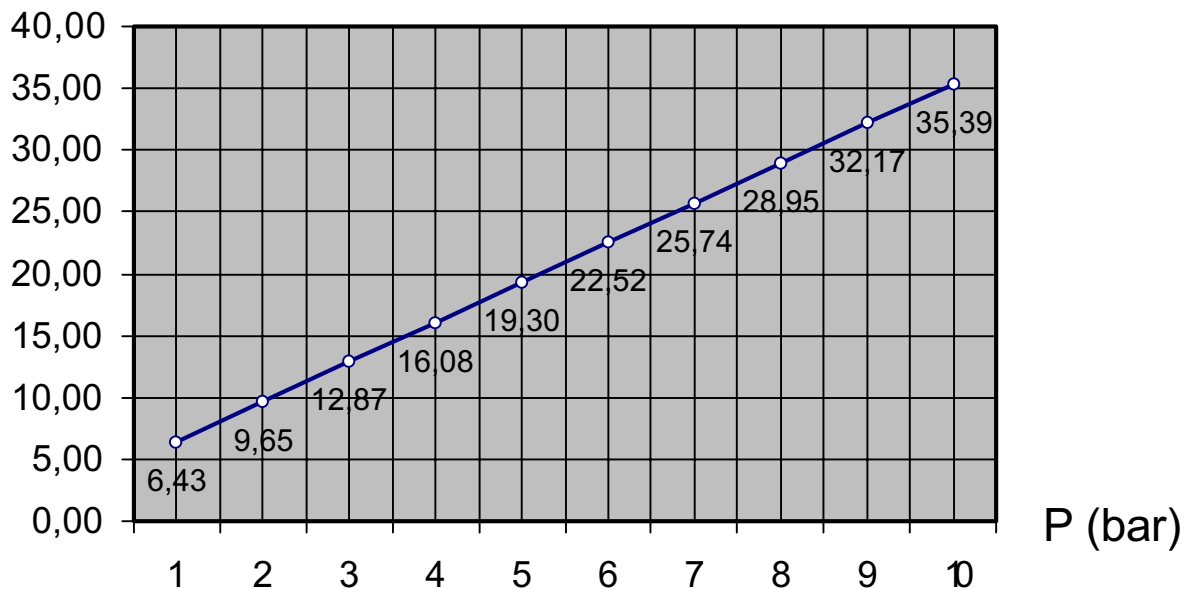

PARA AVANÇO + RETORNO
CURSO 100mm
1 pé³ = 28.3L